



INSTRUCTION MANUAL

YOUR POWERDOT

Thank you for purchasing PowerDot®!

PowerDot uses electrical muscle stimulation (EMS) technology to stimulate your muscles and help you improve muscle performance.

To get the most effective muscle stimulation out of your PowerDot, please read this manual carefully before you start.

For your convenience, you can operate your PowerDot wirelessly using the companion Android or iOS Mobile Application on your Bluetooth Smart Ready mobile phone.

INTENDED USE

PowerDot is a battery-powered neuromuscular stimulator, intended to stimulate healthy muscles in order to improve or facilitate muscle performance and, therefore, can be considered as a technique or method for muscle training.

PowerDot is not intended to be used in conjunction with therapy or treatment diseases of medical or medical conditions of any kind. Electrical stimulation, when effectively combined with regular physical training, can significantly improve the performance of stimulated muscles in just a few weeks' time.

An efficient way to make your muscles work without causing cardiovascular or mental fatigue, electrical stimulation also minimizes the stress on your joints and tendons.

PowerDot stimulation programs and guidelines are based on the latest research by the world's leading sports scientists.

For maximum results, use PowerDot as a sports assistance/supplementary product in combination with a healthy lifestyle that includes regular physical training and a balanced diet.

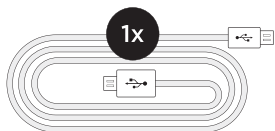
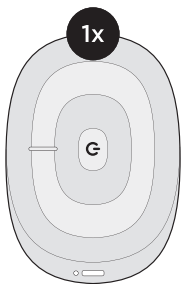
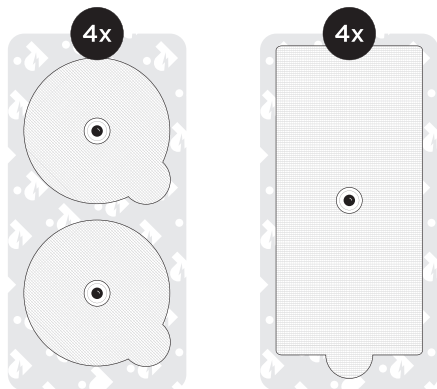
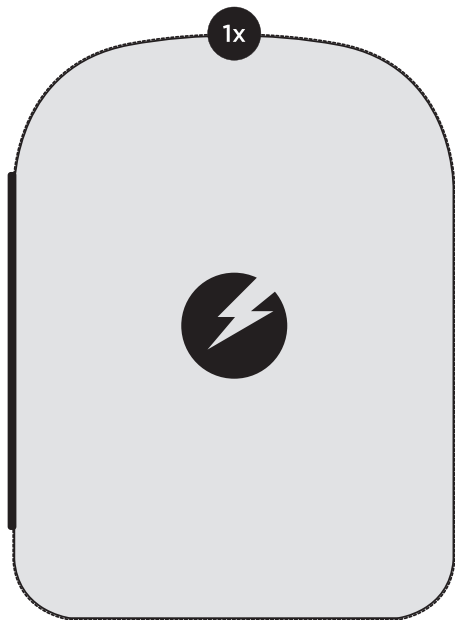

POWERDOT PACKAGE CONTENTS

CARRY CASE

For storing and carrying your PowerDot (or two PowerDots), your working electrode pads and lead cables in between your stimulation sessions.

POWERDOT

Generates and sends electrical signals, via electrode pads, to your muscles, causing them to twitch or contract.

ROUND/RECTANGULAR ADHESIVE ELECTRODE PADS

Self-adhesive electrode pads are connected to the lead cables via snap-on connectors. Always follow the pad placement instructions found in the PowerDot Mobile Application.

USB CHARGING CABLE

For charging and recharging PowerDot, but only from a reliable USB connection. DO NOT use the PowerDot on your muscles while it is still charging.

LEAD CABLES (ELECTRODE CABLES)

Used to transmit electrical signals from the PowerDot device to the electrode pads. PowerDot lead cables are either 10 cm/4" or 30 cm/12" long. Depending on the muscle group you're targeting and on your height/physical measurements, you can use either of these two lead cables (e.g., the 10 cm/4" lead cable will suffice for abdominal muscles, while the 30 cm/12" lead cable will be more suitable for longer quadriceps muscles).

WARNING AND SAFETY GUIDELINES

1 COUNTER-INDICATIONS

NEVER use PowerDot if you have ANY of the following:

Cardiac stimulator (pacemaker), implanted defibrillator or other implanted metallic or electronic device. Such use could cause electric shock, burns, electrical interference or death.

- Epilepsy.
- Cancer or cancerous lesions.
- Any heart problem or condition.
- Pregnancy
- (do not use over the abdominal area).
- Serious arterial circulation disorders in lower limbs.
- Abdominal or inguinal hernia.

2 USAGE PRECAUTIONS

CONSULT YOUR DOCTOR before using PowerDot if you have ANY of the following:

- After trauma or a recent operation (less than 6 months prior).
- Muscle atrophy.
- Persistent pain.
- Need for muscle rehabilitation.

3 SAFETY MEASURES

- Do not charge or re-charge PowerDot when it is attached to any part of your body.
- Do not apply stimulation near the area of an implant, such as cochlear implants, pacemakers, electrical or skeletal anchorage implants or any other active implanted or body worn devices. Such use could cause electric shock, burns, implantable/body worn device malfunction due to electrical interference or death.
- Do not apply stimulation near metal. Remove jewelry, body piercings, belt buckles or any other removable metallic product or device in the area of stimulation.

- If pregnant or menstruating, do not place electrodes directly over the uterus or connect pairs of electrodes across the abdomen.
- Do not use PowerDot in water or in a humid atmosphere (sauna, hydrotherapy, etc.).
- Do not apply stimulation in bath or shower.
- Do not use PowerDot in an oxygen-rich atmosphere.
- Do not connect leads or pads to the other objects.
- During a stimulation session, do not disconnect electrodes when stimulation is running. Stop the stimulation first.
- Do not use the PowerDot while driving, operating machinery, cycling or during any activity in which electrical stimulation can put you at risk of injury.
- Do not apply stimulation while sleeping.
- Do not allow movement resulting from muscular contraction during a stimulation session. You should try to always stimulate in isometric way; this means that the extremities of the limb in which a muscle is being stimulated must be firmly fixed, so as to prevent any movement resulting from contraction.
- Keep PowerDot device and its accessories out of reach of children and pets. Do not allow any foreign objects (soil, water, metal, etc.) to get into the device.
- Do not use the PowerDot unit within 1.5 meters of short wave or unshielded microwave devices as this could alter the current generated by the stimulator. If you have any doubts when using the stimulator in close proximity to another medical device, please contact the device manufacturer or your doctor.
- Sudden temperature changes can cause condensation to build up inside the stimulator. Only use the device once it has reached ambient temperature.
- Do not exert yourself when using electrical muscle stimulation. Any workout should be at a level comfortable for you.
- Do not use the stimulator at altitudes of over 3,000 meters.
- Do not use the stimulator on children.
- Do not use PowerDot if you are connected to a high frequency surgical instrument as this could cause skin irritations or burns under the electrodes.
- Do not use PowerDot in areas where unprotected devices are used to emit electromagnetic radiation. Portable communications equipment, RFID and electromagnetic security systems (e.g. metal detectors and EAS) can interfere with PowerDot and alter the current generated by it.



Some RF emitters, such as RFID systems, might not be visible to you. If you experience unexpected change in stimulation intensities, please terminate stimulation immediately, as advised in section “6. Terminating Stimulation” of this User Manual

- Do not use PowerDot in the close proximity of medical devices such as MRI, CT, diathermy, X-Ray as those could alter the current generated by PowerDot stimulator, cause tissue damage, and can result in severe injury or death. If you have any doubts when using PowerDot stimulator in close proximity to another medical device, please contact the device manufacturer or your doctor.



PowerDot is MR unsafe device. Never use your PowerDot near on in the MRI scanner (magnet) room.

4 PAD PLACEMENT PRECAUTIONS

NEVER attach electrode pads:

- Near or to your head since the effects of stimulation of the brain are unknown.
- On the front and sides of the neck because this could cause severe muscle spasms resulting in closure of your airway, difficulty in breathing, or adverse effects on heart rhythm or blood pressure.
- Across your chest because the introduction of electrical current into the chest may cause rhythm disturbances to your heart, which could be lethal.
- To your front torso (i.e. chest or abs) and back torso (i.e. upper back, lower back) simultaneously.
- Over painful areas. If you have painful areas, you should consult with your physician before using this device.
- Over open wounds or rashes, or over swollen, red, infected, or inflamed areas or skin eruptions (e.g., phlebitis, thrombophlebitis, varicose veins).
- Over, or in proximity to, cancerous lesions.

5 PAD USAGE PRECAUTIONS

- Only use electrode pads supplied by

PowerDot. Other electrodes may cause potential allergic reactions due poor biocompatibility, or have electrical properties that are unsuitable for the PowerDot.

- Replacement PowerDot electrodes can be obtained from PowerDot official distributors, authorized resellers and/or from PowerDot Online Store (<http://powerdot.com>).
- Do not immerse the pads in water.
- Do not apply solvents of any kind to the pads.
- Do not attempt to place pads on any part of the body which is not directly visible without assistance.
- For best results, wash and clean the skin of any oil and dry it before attaching the pads.
- When attaching the pads, please ensure that the entire surface is in contact with the skin.
- For hygienic reasons, each user must have his/her own set of pads. Do not use the same pads on different people.
- Never use a set of adhesive pads for more than 30 stimulation sessions as their bonding power deteriorates overtime and optimal contact is very important for both user comfort and stimulation efficacy.
- Use caution if stimulation is applied over areas of skin that lack normal sensation.

- Use caution if you have a tendency to bleed internally, such as following an injury or fracture.

6 ADVERSE REACTIONS

- Some people with very sensitive skin may experience redness under the pads after the stimulation session. Generally, this redness is completely harmless and disappears after 15 to 20 minutes. However, avoid starting a stimulation session on the same area until the redness is no longer visible.
- You may experience headache and other painful sensations during or following the application of electrical stimulation near your eyes and to your head and face.

You should stop using PowerDot and consult with your physician if you experience adverse reactions from the device.

POWERDOT DEVICE & ACCESSORIES

- ❶ Power/Stimulation Indicator
- ❷ Multifunction Button
- ❸ Micro USB connector (dual function: connects either leads or charging cable)
- ❹ Charging Indicator
- ❺ Snap-on connector
- ❻ Lead cable with two 3.5 mm female snap connectors
- ❼ Rectangular pad with 2.2 mm male snap connector
- ❽ Round pad with 3.5 mm male snap connector

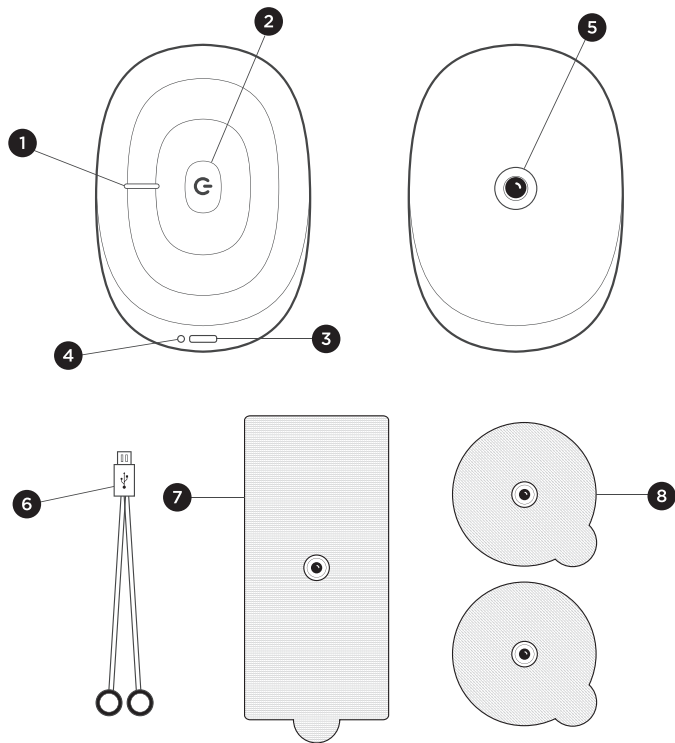

POWER/STIMULATION INDICATOR ❶ :

Can be either WHITE (when the PowerDot is on or on standby mode) or ORANGE (when it's being used for stimulation).

MULTIFUNCTION BUTTON MODES ❷ :

The touch-enabled Multifunction Button carries out these PowerDot functions:

Multifunction Button Action	PowerDot	PowerDot Resulting State
Hold for -1 second	PowerDot is OFF (no lights)	PowerDot is now ON (white light is on)
Quick Click	PowerDot is ON (white light is on)	PowerDot is now OFF (no lights)
Quick Click	PowerDot is in Stimulation (orange light is on)	Stimulation stops (orange light is on)
Hold for 5 seconds	Device is ON	Activation lock is released, Power LED blinks several times, and the PowerDot is OFF

MICRO-USB CONNECTOR ❸ :

PowerDot uses the same high voltage micro-USB connector (3) for lead cable connection and for charging.

If the device is being used for stimulation, it will immediately stop once the lead

cables are disconnected from the micro-USB connector.

CHARGING INDICATOR ❹ :

While the device is still charging, you will see the ORANGE Charging Indicator (4) next to the micro-USB charging connector.

Refer to the **Recharging PowerDot** section below for more information on PowerDot charging.

SNAP-ON CONNECTOR ❺ :

Used to attach and hold the PowerDot device in place on the rectangular pad.

LEAD CABLE ❻ :

For an easier, more comfortable PowerDot stimulation, two lead cables of different lengths (10 cm and 30 cm) (6) are provided with each PowerDot. These give you the option to choose the right cable to reach the muscle group you're targeting, depending on your physical measurements.

ELECTRODE PADS ❼, ❽ :

PowerDot uses two types of electrode pads – one 9x5 cm (3.5"x2") rectangular pad (7) and a pair of 5.5 cm (2.1") round pads (8). The rectangular pad also acts as a holder for the PowerDot device itself.

PowerDot pads use unique skin biocompatible hydrogel with superb conductive qualities and adhesiveness.

The lifetime of the PowerDot pads depends a lot on your individual skin properties, level of hairlessness and the quality of maintenance. On average, each pad lasts for around 25 stimulation sessions. After that, adhesiveness and conductive properties of the pads may start deteriorating.



Store your pads inside the safety film, in a dry environment (either in the original zipper plastic bag or inside the PowerDot carry case). Make sure you attach the pads to clean and dry skin!

DIRECTIONS FOR USE

1 INSTALLING / LAUNCHING THE POWERDOT MOBILE APPLICATION



- 1) Make sure your mobile device a) runs on Android 4.4 (KitKat) or later, and b) is Bluetooth Smart Ready-enabled.
- 2) Click on the Google Play application, search for the “PowerDot” Mobile Application and install it.
- 3) Launch the installed PowerDot application, walk through the on-screen Safety Briefing, then follow instructions to locate and activate your PowerDot (or PowerDots) for the first use.

iOS

- 1) Make sure your mobile phone a) runs on iOS 7.0 or later, and b) is iPhone 4S or later.
- 2) Launch Apple App Store application, search for the “PowerDot” Mobile Application and install it.

3) Launch the installed PowerDot application, walk through the on-screen Safety Briefing, then follow instructions to locate and activate your PowerDot (or PowerDots) for the first use.

2 TURNING POWERDOT ON/OFF

To turn on your PowerDot device, hold down the Multifunction Button for approximately 1 second, until you see the power light turn on. When PowerDot is not in stimulation, you can turn it off by pressing the Multifunction Button.

When a stimulation is ongoing, click on the Multifunction Button twice to turn off the device, as the first click will only stop the stimulation. The second click will turn off PowerDot.

3 ACTIVATING POWERDOT

Before PowerDot can be used for muscle stimulation, it must be activated from within your PowerDot Mobile Application.

When PowerDot is activated, it gets paired with your mobile phone securely. Neither you nor anyone else will be able to connect and use your PowerDot from any other mobile phone.

We will never allow strangers to connect

to and control your PowerDot from their phones!

Follow the Mobile Application’s onscreen advice to scan for and activate your PowerDots. Make sure your PowerDot (or PowerDots) is turned on before you start scanning.

Use the My Device screen (accessible from the PowerDot app menu bar) to activate another or additional PowerDot devices, or to deactivate previously activated ones. You can activate up to two PowerDots at the same time.



Remember, you won’t be able to use your PowerDot (or PowerDots) until you activate it with your PowerDot Mobile Application on your smartphone!

4 PREPARING AND PLACING POWERDOT

1) Plug the lead cable you intend to use into the micro-USB connector on your PowerDot device.

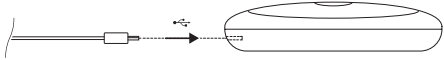

2) Snap on PowerDot to the rectangular electrode pad while the pad is still attached to its safety film.

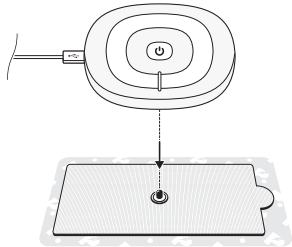

3) Detach the round pads from their safety film and stick them to the targeted part of your body, according to the pad placement visual guidelines found in your PowerDot **Mobile Application**.

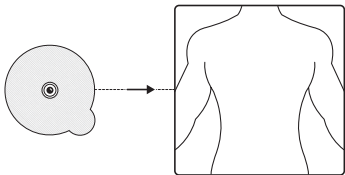

4) Once the PowerDot device and the lead cable are already attached to the rectangular pad, remove the rectangular pad from its safety film and stick it to the targeted part of your body, according to the same pad placement visual guidelines found in your PowerDot **Mobile Application**.

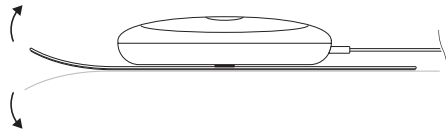

5) Snap on the lead cable connectors to the round pads.

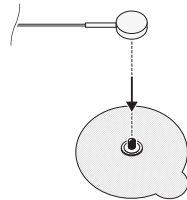

6) Make sure that the entire surface of the round and rectangle pads are completely and securely attached to your body.

7) It's a good time to turn on your PowerDot (or PowerDots), if you haven't done it yet.



Always thoroughly inspect the lead cable and PowerDot device for any signs of damage BEFORE every stimulation session. Do not use damaged accessories or devices. For your safety, you are strongly advised to replace them immediately.

5 LAUNCHING & CONTROLLING A STIMULATION

Once you select a muscle group for stimulation, assemble and place your PowerDot (or PowerDots) and pads as advised above. The **Mobile Application** will automatically check for the remaining battery level and the lead cable connection status.

When the battery level and lead cable connection has been verified, the big red **Get Started** button will appear, which means you can already launch the stimulation session.

Using the Mobile Application, you can control your stimulation session from the **Stimulation Dashboard**, which has these controls:



For first time users, muscle stimulation can be an unusual sensation. We recommend that you begin in recommended stimulation positions, using low stimulation settings to familiarize yourself with the sensation before progressing to higher intensities.



If you experience major discomfort or pain - PAUSE your stimulation session and/or DECREASE intensities. For your safety, after a PAUSE, your stimulation session will resume at only 80% (or less) of your previous intensity values.

Intensity Adjustment controls - Tap on Intensity Increase (or "+") ① and **Intensity Decrease** (or "-") ② buttons for an accurate adjustment, or hold either button down for a faster adjustment. **Stimulation Dashboard Menu** ③ - to access, tap on it or swipe screen up.

Device-level Intensities Lock ④ and **Channel-level Intensities Lock controls** ⑤ synchronize intensity changes either **a)** between the two stimulation channels of one PowerDot device; or **b)** when two PowerDot devices are in use (this applies only to the Duo stimulation mode, which involves two PowerDot devices).

Both controls are enabled by default and can be used to finetune the intensity of your current stimulation session. However, it's best to use them only when you really need them (e.g. for a better balance between your left and right sides, or when your muscles are not evenly developed).

Use Stop (■), Pause (⏸), Resume (▶), Skip Phase (⏭) controls for your stimulation. Skip Phase (⏭) control allows to switch from **Warm Up** to **Main Phase** or from **Main Phase** to **Recovery**.

Timer indicator ⑥ displays the remaining time for the total stimulation session (for all remaining phases) as well as time left for the currently active stimulation phase.

Contraction/Rest Indicator ⑦ - for programs and phases involving muscle contractions, helps to understand time between and during contraction and rest intervals.

Auto-Step Up Indicator ⑧ and **Auto-Step**

Up Control ⑨ - for programs and phases involving muscle contractions, allows to turn on or turn off automatic one step increase in stimulation intensities after every few muscle contractions.

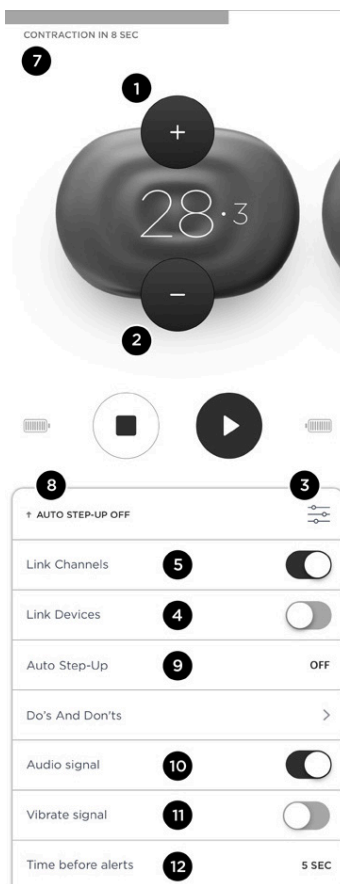

Auto-Step Up is a helpful feature for performance training as muscle fibers are getting used to stimulation intensity levels and, for maximum effectiveness, regular intensity adjustments up are strongly recommended.

Pre-contraction Alerts: configure **Audio Signal** ⑩ and/or **Vibrate Signal** ⑪ alerts to notify you 1 to 5 seconds ahead of next muscle contraction (use **Time Before Alerts** control ⑫ to configure alert timing). This is a helpful feature to use if you are performing dynamic exercises during stimulation.

TERMINATING STIMULATION

It's important to know the quick ways to end your stimulation when something unexpected happens (e.g. one of the pads gets detached; the intensity increases unexpectedly; the stimulation area gets wet, etc.).

There are 3 main ways to immediately terminate stimulation:

- **The recommended/most commonly used option:** Tap **Pause** (⏸) or **Stop** (■) on the Stimulation screen
- **Alternatively:** Press the **Multifunction Button** on your PowerDot (or on any PowerDot when in Duo mode)

- **Only in emergencies:** Unplug the lead cable from PowerDot.

⑥ CARRYING & STORING POWERDOT

PowerDot carry case is specifically designed for carrying and storing your PowerDot device, cables and electrode pads.

To keep electrode pads clean and make them last longer, always re-attach them to the safety film in between uses, then store them in your carrying case pocket. You can use both sides of a single safety film to attach one set of PowerDot electrode pads (one side for the rectangular pad and the other for the two round pads).

⑦ DEACTIVATING POWERDOT

PowerDot can be deactivated and unpaired from a mobile phone either from within the **Mobile Application** or by manually deactivating the device.

For manual deactivation: When PowerDot is ON and not in stimulation, press and hold down the **Multifunction Button** for 5 seconds until you see the power indicator blinking several times. When you turn on your PowerDot again, it will already be deactivated.

Deactivation from the **Mobile Application via My Devices screen**: When your active PowerDot device is on, deactivate it by tapping on the active device. Upon successful deactivation, the power indicator will blink several times.



Forgot to deactivate your device from within the PowerDot Mobile Application? Do it manually by holding down the Multifunction Button on the device for 5 seconds!

GENERAL USAGE GUIDELINES

1 PAD PLACEMENT



ALWAYS follow the pad placement guidelines found in the PowerDot Mobile Application. The manufacturer disclaims all responsibility for injuries, damages and other consequences arising from stimulations where pads placement recommendations were ignored.

Where necessary, look for the best possible position by pausing the stimulation, slowly moving the round pad over the targeted muscle, and resuming stimulation until you find the position that produces the perfect combination of the strongest contractions and the greatest comfort.

2 STIMULATION POSITIONS

The optimal stimulation position will vary depending on the actual placement of the pads, targeted muscle group, and your stimulation program selection.

For **Main Programs**, which generally induce powerful muscular contractions, muscles should always be stimulated in an isometric fashion (for your reference, illustrations will be provided in the Mobile Application.)



ALWAYS follow PowerDot Mobile Application recommendations on the best stimulation position. The manufacturer is not responsible for any damage or injury suffered by users who engaged in physical activities or assumed stimulation positions other than the ones recommended in the Mobile Application's stimulation guidelines.

You should therefore try to arrange your limbs in such a way that you achieve maximum resistance to the movement

and prevent any shortening of the muscle during the contraction.

3 ADJUSTING STIMULATION INTENSITIES

In a stimulated muscle, the number of the recruited fibers depends on the intensity of the stimulation. For Main Programs that simulate powerful muscle contractions: to recruit the maximum number of fibers, stimulate up to intensity levels that you can comfortably endure.

For programs meant to induce muscle twitches: you should progressively increase the stimulation intensities until you see the targeted muscles actually twitching.

The PowerDot **Mobile Application** will always give you the best advice on which intensity levels to use, depending on your selected stimulation program and the current stimulation phase.

Keep in mind that the maximum intensity levels may vary, not only from one stimulation session to another, but also within the course of a single stimulation session. It's possible your muscles will adapt to stimulation at a certain intensity level reasonably quickly. Various

conditions, such as differences in skin's dampness or sweat levels, or the rate of the electrode pad deterioration, may also affect the rate of stimulation.



ALWAYS follow your feelings and sensations when you increase intensities during stimulation. While we advise you to use the maximum intensities that you can tolerate, for some of the stimulation programs, make sure to complete at least several sessions and familiarize yourself with the controls and sensations at the lower and more comfortable intensities, before trying out maximum tolerable levels.

RE-CHARGING POWERDOT

PowerDot can be recharged from any reliable USB connection (e.g. your laptop, mobile phone charger, etc.). It takes around 60 minutes for the device to go from zero to full charge.



NEVER charge or recharge your PowerDot when it is attached to your body.

ALWAYS use the original charging cable provided in your PowerDot package.

NEVER charge or recharge PowerDot from unreliable or problematic sources!

When using 3rd party USB AC chargers, we recommend unplugging the AC plug from the wall before connecting your PowerDot device.

PowerDot uses a built-in Lithium Polymer battery, which requires recharging after

approximately 5-6 hours of continuous use. The battery will last for at least 500 charging cycles.

If you plan to store your PowerDot, unused, for longer than six months, charge it to at least 50% every six months.

In the PowerDot **Mobile Application**, the current PowerDot battery level is always displayed at the **Stimulation Dashboard**.

The **Mobile Application** won't let you launch a new stimulation session if any of your active PowerDot devices is not charged to at least 10%.

When you see the ORANGE charging light next to the micro-USB connector, this means your PowerDot is charging. Once PowerDot is fully charged, the ORANGE light will turn off.

POWERDOT STIMULATION PROGRAMS (PROTOCOLS)

The PowerDot Mobile Application supports a number of builtin stimulation programs and output modes suitable for different sports and relaxation purposes. These programs work best when you combine them with regular physical training.

PowerDot stimulation programs can be divided into two main sections:

1 PERFORMANCE PROGRAMS

Performance Programs are designed to complement your regular sports & fitness workouts, and help you improve and maintain your muscle performance.

It's ideal to run the **Performance Programs** 3-5 times per week during preparatory mid-season period, and 1-2 times per week during competition season or transition periods. Your daily stimulation session should usually involve

stimulation of 1-3 muscle groups of your choice (depending on the specifics and objectives of your sport). If you use only one PowerDot device, you will need to run separate stimulation sessions for the left and the right sides of your muscle groups.

All **Performance Programs** start with: 1) a highly recommended 3-minute **Warm Up**; 2) a **Main Workout** phase (Depending on a program, this can take anywhere from 10 to 50 minutes); and, 3) a highly recommended 5-minute **Recovery** phase.

MUSCLE ENDURANCE

Improves muscle endurance and fatigue resistance. Perfect for complementing your physical endurance training workouts.

For best efficiency, plan your PowerDot Endurance sessions BEFORE your physical workouts.

We recommend using your PowerDot Muscle Endurance Program 4-5 times a week per muscle group during preparation period (pre-season) and 2-3 times a week during competition period (mid-season).

STRENGTH ENDURANCE

Improves muscle ability to resist intense and prolonged effort. Perfect for complementing workouts which focus on both endurance and strength, but with stronger shift towards endurance. Improves muscle tone and definition.

For best efficiency, plan your PowerDot Strength Endurance sessions BEFORE your physical workouts.

We recommend using your Strength Endurance Program 3-4 times a week per muscle group during preparation period (preseason) and 1-2 times a week during competition period (midseason).

RESISTANCE

Improves muscle ability to resist intense and prolonged effort. Perfect for complementing workouts which focus on both endurance and strength, but with stronger shift towards strength. Increases muscle hypertrophy.

For best efficiency, plan your PowerDot Resistance sessions in between or after your physical workouts.

We recommend using your PowerDot

Resistance Program 2-3 times a week per muscle group during preparation period (preseason) and 1 time a week during competition period (midseason).

STRENGTH

Improves muscle strength. Perfect for complementing strength training workouts.

For best efficiency, plan your PowerDot Strength sessions in between your physical workouts and with maximum rest interval possible.

We recommend using your PowerDot Strength Program up to 1-3 times a week per muscle group during preparation period (pre-season) and not more than once time a week during competition (mid-season) or de-training periods.

EXPLOSIVE STRENGTH

Focuses on rapid muscle strength development. Perfect for complementing strength and speed training workouts, including plyometric training.

For best efficiency, plan your PowerDot Explosive Strength sessions in between your physical workouts and with

maximum possible rest interval.

We recommend using your PowerDot Strength Program up to 3 times a week per muscle group during preparation period (preseason) and not more than once week during competition (midseason) or de-training periods.

2 EVERYDAY PROGRAMS

Everyday Programs do not depend as much on meticulous planning and regularity as **Performance Programs** do.

While **Performance Programs** are intensive training programs, **Everyday Programs** are designed either for post-training recovery and relaxation or for pre-training preps.

ACTIVE RECOVERY

Improves and accelerates the muscle recovery after an intensive endurance exercise. Use within 2 hours of intensive workout or competition.

EXTENDED RECOVERY

Same as Active Recovery, but runs longer for better effect.

POTENTIATION

Increases contraction speed and prepares muscles for max power output. Use it 10-15 minutes before important competition events (right after regular warm-ups and stretching).

MASSAGE

Temporarily increases blood circulation in the area applied. Maximize usage during transition (post-season, recovery) period.

BASIC TROUBLESHOOTING

DEVICE DOESN'T TURN ON

PowerDot is probably very low on battery. Charge your PowerDot.

DURING PRE-STIMULATION SET UP, POWERDOT(S) CANNOT BE FOUND (OR ARE NOT CONNECTED)

Check out My Devices screen and make sure that PowerDot device you're trying to use is activated.

Make sure your PowerDot is turned on (the white light is on in the device). If the device is charged and activated, but still doesn't connect: in the case of some Android phones, there may be an issue with the Bluetooth stack. Quit your PowerDot Mobile Application through the Task Manager, restart Bluetooth (via your mobile phone's Settings menu) and try again.

STIMULATION DOES NOT PRODUCE THE USUAL

SENSATION

Check that your electrode pads are firmly attached to your body and are correctly positioned (as advised on the Pre-Stimulation screen). Put the stimulation on pause, re-attach or reposition the pads, then resume the stimulation.

THE STIMULATION CAUSES DISCOMFORT OR A BURNING FEELING

If you're using your standard intensity modes, than most probably your pads are worn out and/or losing their bonding strength. Pause the stimulation and re-attach your pads firmly, then resume stimulation. If the same sensation continues, stop the stimulation and replace your pads.

ELECTRODE PADS DON'T STICK TO THE BODY, OR THE STIMULATION IS SURPRISINGLY VERY WEAK EVEN ON HIGH INTENSITIES.

Replace your electrode pads. Most probably they're worn out. If this doesn't work, check if snap on your lead cable is loose or the cable itself is damaged. In either case, replace the lead cable.

CAN'T ACTIVATE DEVICE OR PHONE STOPPED CONNECTING TO THE DEVICE

If you have problems either activating or connecting to your PowerDot devices:

- Remove all active PowerDots from your application My Devices menu. To remove, tap and hold on the PowerDot device image, then tap on the right top corner cross icon.
- Manually reset your PowerDot (or PowerDots) by holding the button on the device for around 5 seconds, until you see power light blinking several times. Your PowerDot device should be turned on before you perform the manual reset.
- Kill/terminate your PowerDot application.
- Go your phone/tablet Bluetooth Settings and remove/forget all devices which start with PowerDot or aPowerDot. For later Android phone models, clearing Bluetooth caches is also highly recommended (it can be done from Settings → Application Manager → All → Bluetooth).
- Turn Bluetooth on your phone OFF and then ON again.
- Restart your PowerDot application and try to activate your device again.
- If you still have connectivity problem, please send us your phone model, OS

version and the list of actions you have performed to support@powerdot.com. We will respond within 24 hours.

PAD PLACEMENT GUIDELINES

To maximize your stimulation effectiveness and safety, please strictly follow the following visual pad placement guidelines (based on your target muscle group selection, applicable for all stimulation programs):



Application of electrodes near the thorax may increase the risk of cardiac fibrillation. This risk is applicable to Pecs, Lats and Abs placement guidelines below.

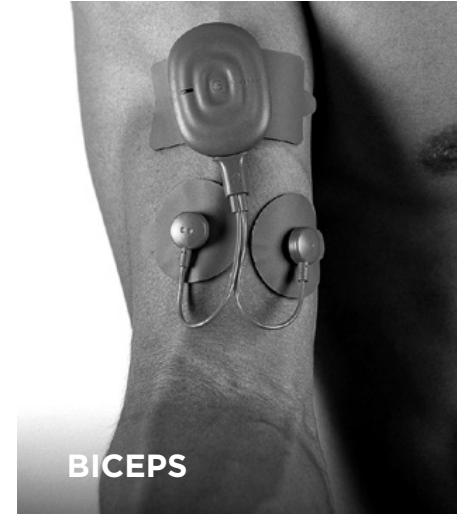
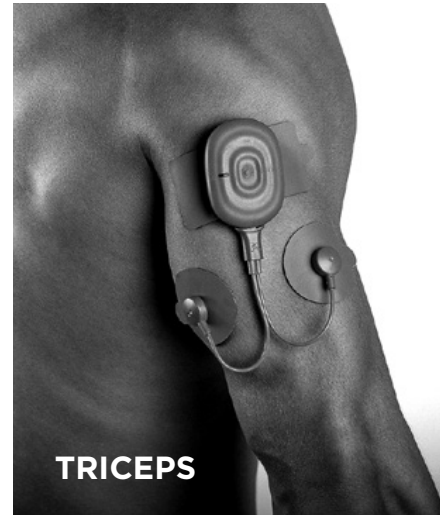
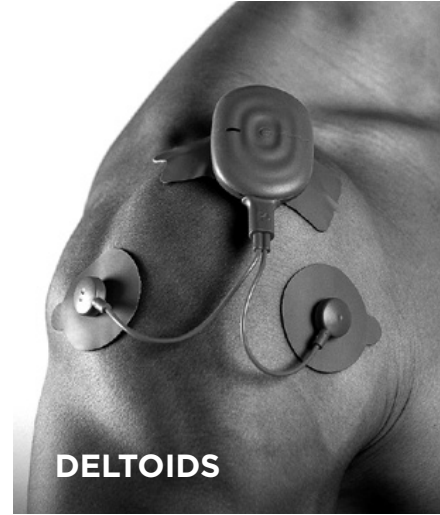
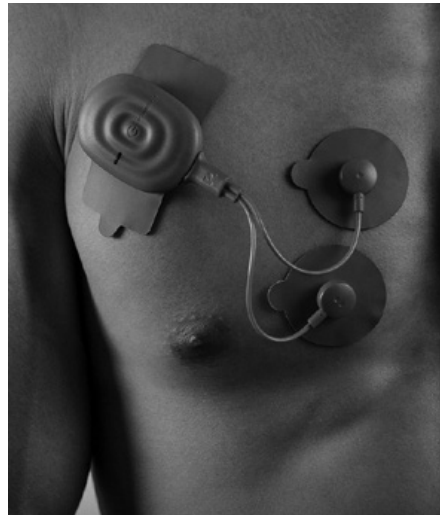
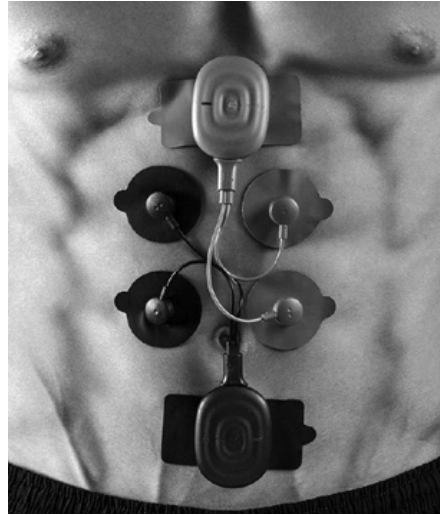

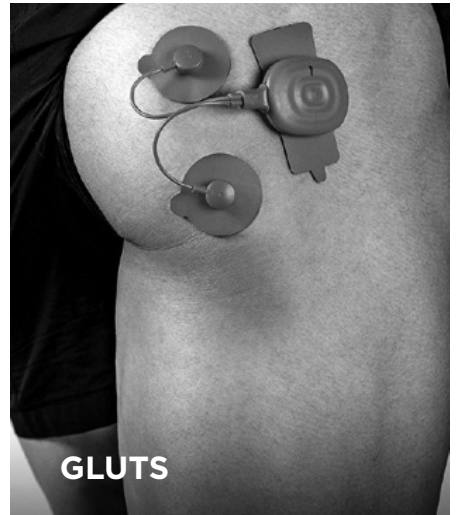
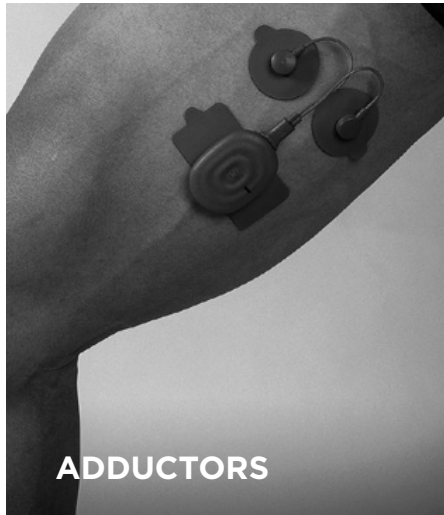
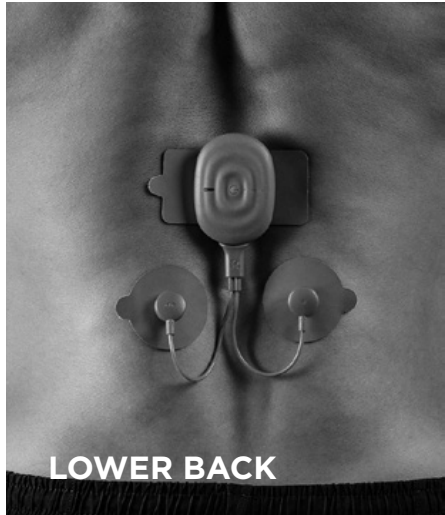
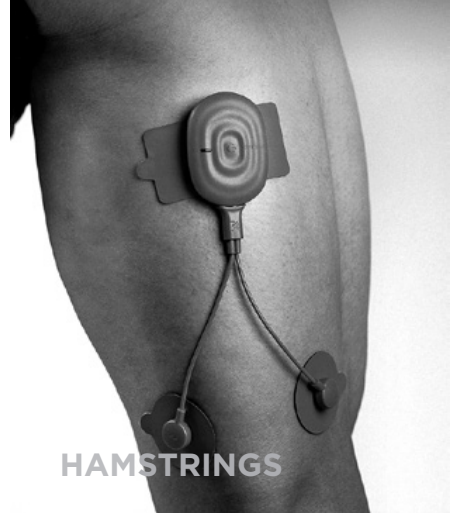
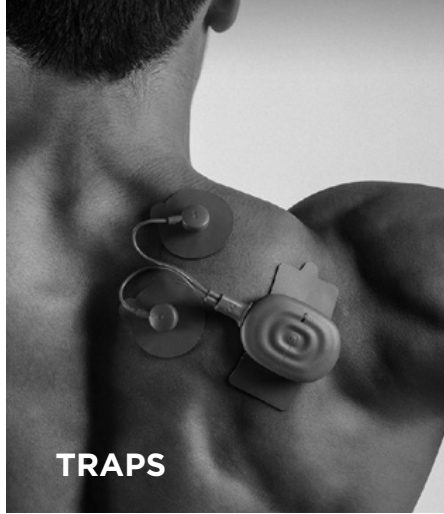
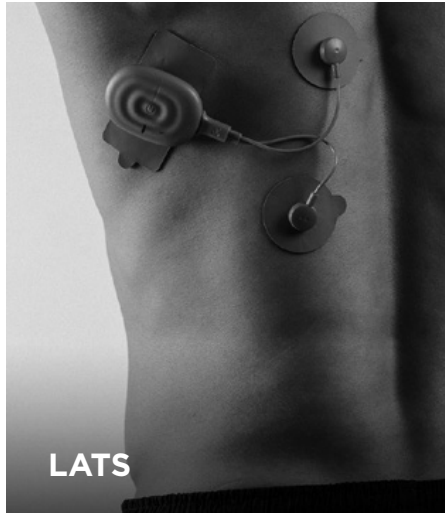

RECOMMENDED STIMULATION POSITIONS

To maximize your stimulation effectiveness and safety, please follow the below stimulation positions recommendations when you run Muscle Endurance, Strength Endurance, Resistance, Strength, Explosive Strength and Potentiation stimulation programs (based on your target muscle group selection):



BICEPS
Sit with your hands locked under your thighs.



TRICEPS
Sit with your arms at 90 degrees



FOREARMS
Make a fist, resist wrist movement



DELTOIDS, TRAPS, PECS, LATS, LOWER BACK, ABS
Sit comfortably



HAMSTRINGS, GLUTES CALVES
Lie on your stomach, resist leg movement



CALVES
Maintain standing position





QUADS, ADDUCTORS
Sit with your legs at 90 degrees, resist leg movement

As Active Recovery, Extended Recovery and Massage programs do not require maximum tolerable intensities to be used, you are allowed to take any comfortable position of your preference and even move freely when running these stimulation programs.

POWERDOT MAINTENANCE

PowerDot device, together with its accessories, should be kept in the PowerDot carry case and carefully stored on a secure surface and protected from conditions listed in the Warnings above.

 Keep replacing your electrode pads after 25-30 uses as recommended. Deteriorated & worn out pads can cause major discomfort during stimulation, affect the effectiveness of the stimulation, and even lead to minor injury.

 Cleaning: only clean your PowerDot device using a dry soft cloth.

 Keep PowerDot device and electrode pads away from water. Store them in a dry place, in protective packaging or in the PowerDot carry case.

PowerDot devices do not require calibration or verification of performance parameters. The characteristics are systemically verified and validated for each device manufactured. Those characteristics are stable and do not vary when used under normal conditions.

The manufacturer states that PowerDot cannot be repaired by personnel external to the company. Any work of this nature carried out by personnel not authorized by the manufacturer will be classified as tampering with the unit, releasing the manufacturer from any responsibility with regards to the warranty and hazards that the operator or user may be exposed to.

POWERDOT WARRANTY

PowerDot is covered by a worldwide warranty of 1 year, which comes into effect on the date of purchase of the device (proof of purchase is required).

The warranty does not apply to the electrode pads and carry cases.

Within the warranty period, manufacturer will replace your faulty PowerDot or accessories at no charge (except shipping & handling fees in some cases), provided that the product:

- Has been used for the intended purpose and in the manner described in this manual.
- Has not been connected to an unsuitable power source.
- Has not been subjected to misuse or neglect.
- Has not been modified or repaired.
- Has not been damaged further by shock.

Legal rights are not affected by this warranty.

ELIMINATION

European Directive 2002/96/CEE (WEEE) has a first priority, the prevention of waste electrical and electronic equipment, and in addition, the re-use, recycling and other forms of recovery of such wastes so as to reduce the disposal of waste:

- The pictogram wheeled bin barred means that the equipment can't be thrown with the household refuse, but that it makes the object of a selective collection;
- The equipment has to be given to a suitable collection point for the treatment;
- By this way, you contribute to the safeguarding of the natural resources and the human health protection;
- Batteries must be disposed of in accordance with your country's national laws governing the disposal of such items.

TECHNICAL SPECIFICATIONS

All electrical specifications are given for an impedance of 1000 Ω per channel.

Battery: Lithium Polymer (LiPo) rechargeable 3.7 V, 210 mAh (-5-6 hours of continuous stimulation on average parameters).

Charging Input: 5V through USB 2.0 or 3.0 connection (custom micro-USB to USB charging cable is provided as part of the package), I/P rating: 5Vdc 1-2.1A.

Stimulation Channels: 2 independent.

Stimulation Waveform: Assymetrical biphasic with zero mean.

Supported Stimulation Frequency Range: 1-120 Hz.

Supported Stimulation Pulse Width: 150-400 μ S (for main/positive phase).

Maximum output voltage/amperage: 115 V/115 mA (+-5%, for 150 μ S pulses).

Bluetooth: Built-in Bluetooth LE 4.0 module.

Electro-compatibility (EMC): ETSI EN 301 489-1/EN 301 489-17/EN 50385/EN 55011/EN 60601-1-2.

C RF Data:

- Operating Frequency Range: 2402 MHz-2480 MHz (ISM range).
- Modulation Type: GFSK with AFH.
- Peak Transmit Power: -15.86dBm (0.026 mW).
- Channel Spacing/Number of Channels: 2 MHz, 40 channels (3 for advertising, 37 for data).
- Antenna Type: Multilayer Chip Antenna, 2 dBi (1.58 mW) gain.

Mobile Application Compatibility:

- Android 4.4 KitKat (or later) powered smart phone with Bluetooth Smart Ready compatibility and HD (or better) touch screen.
- Apple iPhone 4S (or later) smart phone powered by iOS 7.0 (or later).

Device Dimensions: 60.4x43.5x13.6 mm.

Device Weight: 25 g.

Environment Specifications:

- **Operating/Storage/Transport:** Temperature from 0 C to +40 C.
- **Humidity:** 10-90% RH.
- **Atmospheric pressure:** from 700 hPa to 1060 hPa.

Product Expected Lifetime: 5 years.

Housing: ABS & TPU.

Limitations: product is not suitable for use in the environments with a high concentration of oxygen and/or flammable liquids and/or flammable gas; do not use with equipment for electro surgery or short-wave or microwave therapy; the device may be interfered by other equipment, even if that other equipment complies with CISPR EMISSION requirements.

PowerDot PD-01 has been tested to the compliance with the following Emission and Immunity standards:

EMISSION:

Standard	Item	Remarks
CISPR 11: 2011	Conducted	Class B
	Radiated	Class B
IEC 61000-3-2:2014	Harmonic current emissions	
IEC 61000-3-3:2013	Voltage fluctuations & flicker	

IMMUNITY:

Standard	Item	IEC 60601-1-2 Test Levels for Home Healthcare Environment	PowerDot PD-01 Test Levels	Remarks
IEC 61000-4-2:2008	ESD	± 8 kV contact; ± 2 kV, ± 4 kV, ± 8 kV, ± 15 kV air	± 2 kV, ± 4 kV, ± 8 kV contact; ± 2 kV, ± 4 kV, ± 8 kV, ± 15 kV air	No performance degradation observed.
IEC 61000-4-3:2010	RS	10 V/m 80 MHz - 2.7 GHz 80% AM at 1 kHz	10 V/m 80 MHz - 5.785 GHz 80% AM at 1 kHz	No performance degradation observed.
IEC 61000-4-4:2012	EFT	± 2 kV 100 kHz repetition frequency	± 2 kV 100 kHz repetition frequency	No performance degradation observed.
IEC 61000-4-5:2014	Surge	± 0.5 kV, ± 1 kV	± 0.5 kV, ± 1 kV	No performance degradation observed.
IEC 61000-4-6:2013	CS	3V 0.15 MHz - 80 MHz 6V in ISM and amateur bands between 0.15 MHz and 80 MHz 80% AM at 1 kHz	10V 0.15 MHz - 80 MHz 80% AM at 1 kHz	No performance degradation observed.
IEC 61000-4-8:2009	PFMF	30 A/m 50 Hz or 60 Hz	± 0.5 kV, ± 1 kV	No performance degradation observed.

IEC 61000-4-11:2004	Voltage dips & voltage variations	<p>Voltage Dips:</p> <p>1) 0% UT; 0,5 cycle at 0°, 45°, 90°, 135°, 225°, 270°, 315°</p> <p>2) 0% UT; 1 cycle;</p> <p>Single phase at 0°</p> <p>3) 70% UT; 25/30 cycles; Single phase at 0°</p> <p>Voltage Interruptions:</p> <p>0% UT; 250/300 cycle;</p>	As on the previous column	<p>Voltage Dips:</p> <p>1) No performance degradation observed.</p> <p>2) No performance degradation observed.</p> <p>3) No performance degradation observed.</p> <p>Voltage Interruptions:</p> <p>Performance degradation (device stopped charging) has been observed only during voltage interruption testing, but no degradation observed after the testing.</p>
---------------------	-----------------------------------	---	---------------------------	---

BLUETOOTH® COMPATIBILITY

The unique feature of PowerDot is that it's controlled through Bluetooth Low Energy wireless radio interface.

PowerDot is specifically designed to be used together with PowerDot **Mobile Application**, which is supported for select Android and iOS mobile devices.

SECURE PAIRING

Your PowerDot is paired with your mobile phone using secure 8 digit numeric code which, by design, prohibits any other mobile phones or wireless devices to connect to your PowerDot. Secure pairing takes place during PowerDot activation process (see Activating PowerDot above) and, once your PowerDot becomes active, numeric activation code is written into PowerDot's flash memory and gets verified by your PowerDot **Mobile Application** after every PowerDot restart.

All Bluetooth commands sent from your mobile phone to PowerDot device are securely encrypted using Bluetooth AES-128 encryption protocol.

DISCONNECTIONS AND QUALITY OF SERVICE

PowerDot **Mobile Application** and PowerDot PD-01 Bluetooth communication interface are specifically designed to accommodate temporary and permanent Bluetooth disconnections during a stimulation session.

PowerDot PD-01 device is capable of independent execution of a pre-loaded stimulation program with the latest intensity values as well as implement automatic Bluetooth® reconnections.

In this regard, temporary radio frequency interference (e.g. caused by co-existence of multiple Bluetooth and/ or Wi-Fi devices in your range) will not affect the overall efficiency and safety of your stimulation.

Due to hardware-level emergency stop mechanisms (see **Directions For Use**), Bluetooth disconnections of a more permanent nature should not affect the safety of stimulation, and can only

cause a temporary inconvenience by forcing you to postpone your planned stimulation session until a more favorable Bluetooth connectivity environment is established.

Like any wireless device, PowerDot PD-01 emits very low levels in the radio frequency (RF) interval, and is therefore not likely to cause any interference with nearby electronic equipment (e.g., radios, computers, telephones etc.).

PowerDot PD-01 is designed to withstand foreseeable disturbances originating from electrostatic discharges, mains supply magnetic fields, or radio frequency transmitters.

Despite this, it is not possible to guarantee that the stimulator will not be affected by strong RF (radio frequency) fields emitting from other sources.



Try not to use PowerDot closer than 1.5 meters to the working microwave oven as radio interference from microwave is likely to cause disconnection between PowerDot and your mobile phone.



TROUBLESHOOTING WIRELESS CONNECTIVITY

If you run into issues with Bluetooth wireless connectivity (e.g. your PowerDot device becomes unresponsive to PowerDot **Mobile Application** commands during stimulation session or you were not able to connect to your PowerDot and initiate stimulation), do not panic and consider terminating your stimulation session manually by shortly pressing Power button on your PowerDot device.



Your PowerDot **Mobile Application** has built-in re-connection and disconnection detection mechanism and, in most cases, it will re-connect back to your PowerDot shortly and allow you to resume your stimulation using Resume button on the stimulation screen.



If you fail to re-connect and resume stimulation after several attempts, consider stopping your stimulation session using Stop button on the Stimulation Screen and postponing it for later.

NORMALIZED SYMBOLS

SN	Serial Number
	Stand by
	Attention
	Direct Current (DC)

EU ONLY

	This symbol on your PowerDot unit is to indicate conformity with the requirements of the Medical Device Directive (94/42/EEC)
	Manufacturer

	EU Authorized representative
	Internally powered device Class II with Type BF applied parts
	Product subject to WEEE regulations concerning separate waste collection
	Read the instructions for use carefully before using this device
IP 22	Protected from touch by hands greater than 12 millimeters and from water spray less than 15 degrees from vertical.

The device complies with Part 15 of FCC. Operation is subject to the following conditions:

- This device may not cause harmful interference.
- This device must accept any interference received, including interference that may cause undesired operation.

FCC ID: 2AC2KPD001201400SMT

MANUFACTURER & AFTER-SALE SERVICE

MANUFACTURER:

Smartmissimo Technologies Pte Ltd
4 Shenton Way, #28-01 SGX Centre II
Singapore 068807
E-Mail: support@getpowerdot.com

Contact manufacturer for any assistance in setting up, using, maintaining, or reporting unexpected operation or events.

EU AUTHORISED REPRESENTATIVE:

Medical Technology Promedt Consulting GbmH, Altenhostrasse 80, 66386, St. Ingbert, Germany
Phone: (+49) 6894 581020
E-Mail: info@mt-procons.com

ELECTRODE PADS MANUFACTURER:

ZMI Electronics Ltd.,
6F-1, No. 286-4, Shin Ya Road,
Chien Chen District,
Kaohsiung, Taiwan, R.O.C.

ELECTRODE PADS EU AUTHORIZED REPRESENTATIVE:

Geoffrey Jerrom-Pugh,
Lower Barn, The Bayntons,
Vicarage Road, Napton, Southham,
Warwickshire, CV47 8NA, UK



ELECTROMAGNETIC COMPATIBILITY (EMC)

PowerDot PD-01 is designed to be used in home healthcare environments in accordance with the EMC safety standard IEC 60601-1-2 (4th Edition) and with limitations, defined by the warnings and precautions in this manual (e.g. operation near RFID emitters, working microwave ovens, etc.).

Examples of home healthcare environment include restaurants, cafes, shops, stores, markets, schools, churches, libraries, outdoors (streets, sidewalks, parks), domiciles (residences, homes, nursing homes), vehicles (cars, buses, trains, boats, planes, helicopters), train stations, bus stations, airports, hotels, hostels, pensions, museums, theaters.

PowerDot PD-01 is designed to support anticipated disturbance originating from electrostatic discharge, magnetic fields for the power supply or radio-frequency emitters.

However, the performance of PowerDot PD-01 device can still be affected by radio frequency fields originating from other sources.

For more information about EMC emissions and immunity, contact Smartmissimo Technologies.

 The device should not be used adjacent to or stacked with other equipment. If adjacent or stacked use is necessary, the device should be observed to verify normal operation in the configuration in which it will be used.

 The use of accessories, transducers and cables others than those specified or provided by the manufacturer of this equipment could result in increased electromagnetic emissions or decreased electromagnetic immunity of this equipment and result in improper operation.

 Portable RF communications equipment (including peripherals such as antenna cables and external antennas) should be used no closer than 30 cm (12 inches) to any part of the PowerDot PD-01, including cables specified by the manufacturer. Otherwise, degradation of the performance of this equipment could occur.

 PowerDot battery charging performance might degrade in environments with frequent voltage interruptions (when charging from a wall adapter). To support consistent and reliable charging, the usage of UPS is highly recommended, if operating in such environments.

The following device function is considered essential to the safety of the user: ability to maintain consistent stimulation intensity (amplitude), pulse frequency and pulse waveform (both shape and width).

In case if the essential performance is lost or degraded due to electromagnetic disturbances, stimulation safety and effectiveness can be compromised. Whenever the user realizes unexpected change in any of stimulation parameters, it is advised to terminate the stimulation session immediately by using one of the methods provided in the Terminating Stimulation section.

CONTENTS

Your PowerDot EMC	3
Intended Use	3
PowerDot Package Contents	5
Warning And Safety Guidelines	6
PowerDot Device & Accessories	10
Directions For Use	12
General Usage Guidelines	18
Re-Charging PowerDot	20
PowerDot Stimulation Programs (Protocols)	21
Basic Troubleshooting	24
Pad Placement Guidelines	26
Recommended Stimulation Positions	30
PowerDot Maintenance	32
PowerDot Warranty	33
Technical Specifications	34
Normalized Symbols	40
Manufacturer & After-Sale Service	41
Electromagnetic Compatibility (EMC)	42

