

AKASO

BRAVE 8

ACTION CAMERA



USER MANUAL

V2.7

CONTENTS

What's in the Box	01	>>
Your Brave 8	02	>>
Getting Started	05	>>
Overview Of Modes	07	>>
Image Stabilization	08	>>
Quick Menu	09	>>
System Settings	09	>>
Setting Resolution	12	>>
Personalized Settings	13	>>
Connecting to the AKASO GO App	17	>>
Playing Back Your Content	23	>>
Connecting to USB	24	>>
Maintaining Your Camera	24	>>
Maintaining Your Battery	25	>>
Remote Control	26	>>
Accessories	29	>>
Contact Us	30	>>

What's in the Box



AKASO Brave 8
x 1



Camera Frame
x 1



Battery Charger
x 1



Battery
x 2



USB Cable
x 1



Remote Control
x 1



Remote Control
Strap x 1



Spanner
x 1



Helmet Mount 1
x 1



Helmet Mount 2
x 1



Buckle Mount
x 1



J-Hook Mount
x 1



E Mount
x 1



C Mount
x 1



D Mount
x 1



F Mount
x 1



A Mount
x 1



H Mount
x 1



Bandage
x 4



Tether
x 5



Lens Cloth
x 1



Double-Sided
Adhesive Tape x 2



Quick Start Guide
x 1



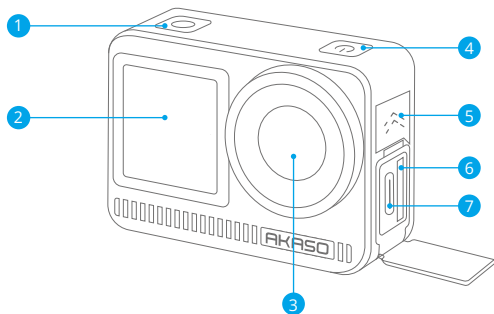

- ① Shutter / OK Button
- ② Front Screen
- ③ Lens
- ④ Power Button
- ⑤ Speaker
- ⑥ Memory Card Slot
- ⑦ USB / External Mic Port



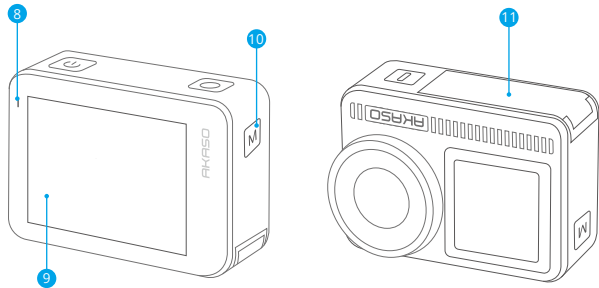

- 8 Charging/Wifi Indicator
- 9 Touchscreen
- 10 Mode Button
- 11 Battery Cover

Button Operation Instructions

• Power Button:

Press to turn on the display screen; press and hold to power on or off.

• Mode Button:

On the preview screen, press the Mode button to switch shooting modes; press and hold the button to switch between the front and touch screens.

• Shutter Button:

In Photo or Video mode, press the Shutter button to capture photos or start video recording. To stop recording in Video mode, press the Shutter button again.

Note:

1. Screen switching is not possible while recording.
2. The touchscreen can't be operated when using the front screen, and vice versa.

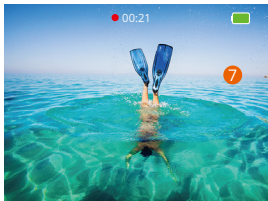
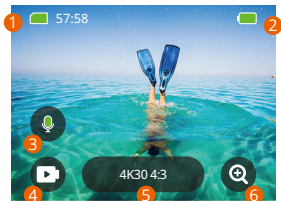

1. Memory Card

See the remaining recording time/number of photos.

2. Battery Level

See the percentage of battery.

3. Audio Recording

Turn audio recording on or off. When disabled, the camera will record video without audio, and vice versa.

4. Capture Mode

See the current mode or switch shooting modes.

5. Resolution and Aspect Ratio

See or configure the resolution and aspect ratio.

6. Zoom

Adjust the viewing angles.

7. Preview Screen

Access the camera status.

Note: The camera will not record sound when it is in the waterproof case.

Getting Started

Welcome to your AKASO Brave 8. To capture videos and photos, you will need a memory card (sold separately) that meets the following requirements.

Memory Card Use

1. Rated Class V30, UHS-3, or higher.
2. Capacity up to 512GB (FAT32).

Tips:

1. Format the memory card in the camera before using it to ensure compatibility. Regularly reformat your memory card for optimal performance. Remember, reformatting erases all data, so transfer your photos and videos before reformatting.
2. Memory cards larger than the specified maximum capacity can cause issues like non-recognition or even camera malfunctions like unresponsiveness or firmware failure.
3. With FAT32, the card will stop recording and create a new file if the file size of a recording reaches 4GB.

Notes:

1. Don't use the card near strong currents or magnetic fields.
2. Don't let the card touch metal objects, or use any metal tools on it case it's squeezed, bent, or falls.
3. Store the card in dry places away from corrosive substances.
4. Ensure that no foreign items are inserted into the card slot.
5. Turn off the camera before inserting or removing the card.

Powering on or off

To power on:

While the camera is off, press and hold the Power button to turn it on.

To power off:

While the camera is on, press and hold the Power button to turn it off.

Zooming in or out:

You can adjust the viewing angle by tapping the "+" icon on the screen.



Quick Start Guide

When using the camera for the first time or after resetting it, set the system language, date & time, and follow the on-camera guide to begin using the camera. If you prefer not to use the guide, simply tap "Skip" to bypass it.

Quick Operation Guide

Swipe down from the preview screen to open the quick menu.

Swipe up from the preview screen to enter the video or photo settings screen.

Swipe right from the preview screen to enter the mode menu.

Swipe left from the preview screen to enter the playback screen.

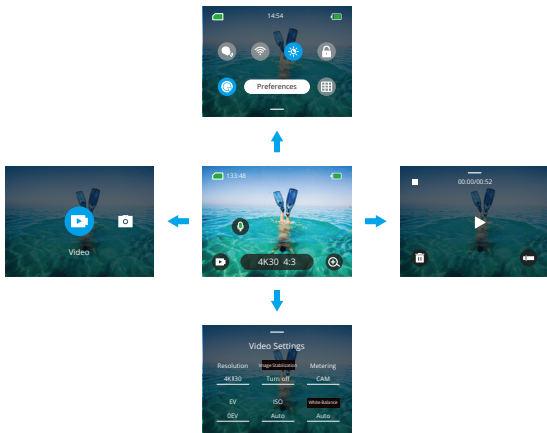

- **Mode Switching:**

When on the preview screen, swipe right or tap the Mode icon to access the mode menu, choose "Video" or "Photo", then swipe left or right to select a desired shooting mode.

- **General Settings:**

Swipe down to access the preferences screen, then scroll down to General Settings and set up your Brave 8 camera.

- **Playback:**

Swipe left to enter the playback screen, tap the Square icon in the upper left corner to enter the album screen, then tap "Video" or "Photo" to enter the video or photo set for file playback.

- **Video / Photo Settings:**

Swipe up to enter the video or photo settings screen, and configure the settings per your needs.

Overview of Modes

The Brave 8 action camera offers 6 shooting modes.

Video Modes

Video Mode

The camera is in Video Mode by default when turned on. When in this mode, press the Shutter button to record normal video at the preset resolution and frame rate.

Time Lapse Video Mode

Time Lapse Video condenses longer events into brief clips by capturing frames at designated intervals. For instance, recording a 20-minute span at a 2-second interval produces a 20-second fast-motion video, whereas a 10-second interval results in a 4-second fast-motion clip.

HyperLapse Mode

The HyperLapse mode enables the camera to produce steady and fluid fast-motion videos, seemingly faster than real-time. This mode is perfect for capturing dynamic scenes. For instance, a 6-minute video captured at a 2X shutter speed results in a



3-minute fast-motion video, while using a 10X shutter speed gives a 36-second fast-motion video.

Slow Motion Mode

The Slow Motion mode allows the camera to capture footage at your chosen resolution and speed ratio, but it saves the video at a playback rate of 30 fps. This ensures that on playback, the video displays in a captivating slow-motion effect. For instance, a 10-second clip shot at 720P 4X results in a 40-second video played at 720P30fps. Essentially, the video is played four times slower, making this mode perfect for capturing fast-moving scenes.

Photo Modes

Photo Mode

In this mode, press the Shutter button to take a photo. Or adjust the burst photo menu to take several photos at the same time. You can also adjust the countdown menu to take a timed selfie.

Time Lapse Photo Mode

In this mode, the camera automatically starts the preset countdown to take a photo when the shutter button is pressed. The process repeats continuously until you press the shutter button again. For instance, when you set "Interval" to "5 Sec", then press the Shutter button, the camera will count down 5 seconds and take a photo, then repeat this process continuously. To stop capturing, press the Shutter button again.

Image Stabilization

The Brave 8 action camera can efficiently smooth out the lens shakes, resulting in smooth and pristine videos thanks to its Electronic Image Stabilization and SuperSmooth Stabilization algorithms. This feature is ideal for capturing scenes involving activities like riding, skating, and handheld use.

Tip: SuperSmooth stabilization is an upgraded in-app image stabilization mode that delivers ultra-smooth footage. To achieve this, the SuperSmooth stabilization algorithm is applied via the AKASO GO app. For SuperSmooth results, record a video with the "SuperSmooth" option selected, then download the stabilized video via the AKASO app.



Quick Menu

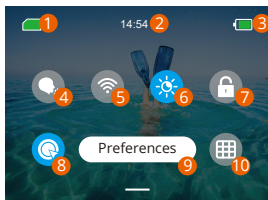

- | | |
|------------------------|--------------------------------|
| 1 Memory Card Capacity | 6 Screen Brightness (3 Levels) |
| 2 Time | 7 Screen Lock |
| 3 Battery Level | 8 One Key Fast Shooting |
| 4 Voice Control | 9 Preferences |
| 5 Wifi | 10 Grid |

System Settings

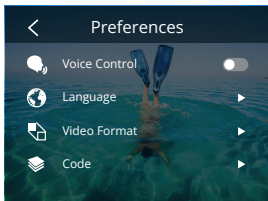

You can dive into the System Settings to adjust your Preferences and General Settings.



Functions	Specifications	Note
Voice Control	Turn on /Turn off (default)	Voice Control offers hands-free operation using supported voice commands. With this feature enabled, you can issue any supported voice command to the camera. The camera will respond to the given voice commands and execute various functions.
Language	English/Deutsch/Français/ Español/Italiano/日本語/ 简体中文/繁體中文/한국인	9 languages supported.
Video Format	NTSC (default)/PAL	
Code	H.264 (default)/H.265	Select a desired video code, each offering different image effects and compression ratios.
Wireless Connection	Turn on/Turn off (default) Connecting Device Camera Information Wifi Band-5G (default)/2.4G	Connect your action camera to the AKASO GO app using the camera's built-in Wifi.
Remote	Turn on /Turn off (default)	Pair your camera with the included remote for remote operation.
One Key Fast Shooting	Turn on /Turn off (default)	With this feature enabled, the camera will automatically turn on and start recording as soon as you press the Shutter button. To stop recording and turn off the camera, simply press Shutter button again. The camera will automatically save the file and power off. Tip: You can also turn this feature on or off on the quick menu; if you do not wish to use this feature, press and hold the Power to turn on the camera.
Gyroscope	Turn on / Turn off (default)	The camera's built-in 6-axis gyroscope can detect how you hold the camera, allowing for a more enjoyable capture experience. With Gyroscope enabled, the camera intuitively captures vertical shots when held upright, and switches to wide screen when held sideways.

General Settings		
Screen Brightness	0-100%	Adjusts the screen brightness.
Sound	0-100% - Volume On (default)/Off- Key Tone Beep Tone Photo Beep Tone	Adjusts camera sounds to an acceptable level.
Indicator Light	Turn on /Turn off (default)	
Video Sound	Turn on /Turn off (default)	
Auto Power Off	Never/2 Minutes/5 Minutes (default)/10 Minutes / 20 Minutes/30 Minutes	
Screen Saver	Never/15 seconds/30 seconds/ 1 Minute (default)/ 2 Minutes/ 5 Minutes	
Date & Time	Date: YY/MM/DD Time: HH/MM (AM/PM/ 24-hour System)	
Date Stamp	Turn on /Turn off (default)	
Formatting	Format Memory Card - Cancel/ Confirm Memory Card Capacity	
Factory Reset	Cancel/Confirm	
Voice Commands	AKASO Video Start AKASO Stop Video AKASO Take Photo AKASO Power off	Check all the supported voice commands under this setting.
About	Brand/Model/Version	View camera information

Setting Resolution

On the preview screen, tap the resolution icon at the bottom of to access the resolution settings screen, then swipe left or right to choose the desired resolution. You can also set the image stabilization on this screen. After the configuration is complete, swipe down to exit.

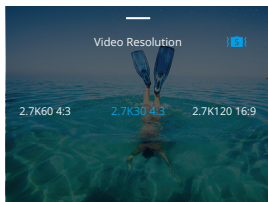
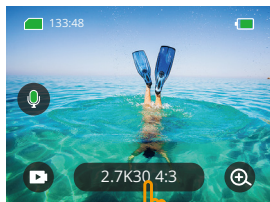

Video Modes

Functions	Specifications
Video Mode	NTSC: 4K30 4:3/4K60 16:9/4K30 16:9/2.7K90 4:3/2.7K60 4:3/2.7K30 4:3/ 2.7K120 16:9/2.7K90 16:9/2.7K60 16:9/2.7K30 16:9/1440P180/1440P120/ 1440P90/1440P60/1440P30/1080P200/1080P120/1080P90/1080P60/1080P30 PAL: 4K25 4:3/4K50 16:9/4K25 16:9/2.7K75 4:3/2.7K50 4:3/2.7K25 4:3/ 2.7K100 16:9/2.7K75 16:9/2.7K50 16:9/2.7K25 16:9/1440P150/1440P100/ 1440P75/1440P50/1440P25/1080P200/1080P100/1080P75/1080P50/1080P25
Time Lapse Video Mode	Resolution: 8K/4K4:3/4K16:9/2.7K4:3/2.7K16:9/1440P/1080P Interval: 2s/5s/10s/30s/1min/2min/5min/10min/30min/1h
HyperLapse Mode	Resolution: 4K 16:9/2.7K 4:3/2.7K 16:9/1440P/1080P HyperLapse Speed: 2x/5x/10x/15x/30x
Slow Motion Mode	Resolution: 2.7K/1440P/1080P/720P Slow Motion Speed: 2x/4x/8x/16x
Image Stabilization	Off / Normal / SuperSmooth

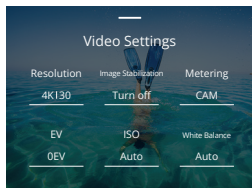
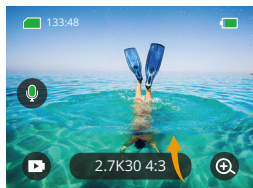

Photo Modes

Functions	Specifications
Photo Mode	Resolution: 48MP (default)/12MP
Time Lapse Photo Mode	Resolution: 48MP (default)/12MP Interval: 0.5s/1s/2s/5s/10s/30s/1min/2min/5min/10min/30min/1h

Personalized Settings

On the preview screen, swipe up to access the video or photo settings screens. Specifications are as follows:



Video Settings

Functions	Specifications	Note
Resolution Ratio	4K30 4:3/4K60 16:9/4K30 16:9/2.7K90 4:3/2.7K60 4:3/2.7K30 4:3/2.7K120 16:9/2.7K90 16:9/2.7K60 16:9/2.7K30 16:9/1440P180/1440P120/1440P90/1440P60/1440P30/1080P200/1080P120/1080P90/1080P60/1080P30	Video Mode
	8K16:9/4K4:3/4K16:9/2.7K4:3/2.7K16:9/1440P/1080P Interval: 2s/5s/10s/30s/1min/2min/5min/10min/30min/1h Hyperlapse Speed: 2x/5x/6x/10x/15x/30x	Time Lapse Video Mode/ HyperLapse Mode



	Resolution: 2.7K/1440P/ 1080P/720P Slow Motion Speed: 2x/4x/8x/16x	Slow Motion Mode
Image Stabilization	Turn off (default) /Normal/ SuperSmooth	Turn off: Turn off Image Stabilization. Normal: The in-camera stabilization mode uses the electronic image stabilization algorithm along with a 6-axis gyroscope, ensuring shake-free footage. SuperSmooth: An upgraded in-app image stabilization mode that delivers ultra-smooth footage.
Metering	CAM (default) /AM/CM/SM/AFM	CAM (Center Average Metering): Prioritizes the scene's center but also considers surrounding areas. AM (Average Metering): A metering mode that bases the whole screen. CM (Center Metering): Emphasizes the scene's center, making it ideal for selfies or close-up shots, like flowers. SM (Spot Metering): Targets a specific spot in the scene to determine exposure. AFM (AI Face Metering): A smart mode that adjusts exposure based on detected facial features, enhancing selfies.
EV	3.0/2.5/2.0/1.5/1.0/0.5/0(default)/ -0.5/-1.0/-1.5/-2.0/-2.5/-3.0	Sets the brightness of photos and videos. A higher EV value creates a brighter image.
ISO	Auto(default) /100/200/400/ 800/1600/ 3200/6400	Sets the image sensor's sensitivity to light.
White Balance	Auto(default) /2300K/2800K/3200 K/4000K /4500K/5000K/5500K/ 6000k/ 6500K	Fine-tunes the color temperature of your videos and photos.
Sharpness	0/1/2/3 (default) /4/5/6	Sets the level of detail in your photos and videos.
Bit Rate	High (default)/Medium/Low	Influences the file size. A lower the bit rate results in a smaller file size.
Color	Normal (default) /Vivid	Selects the tonal quality.

Fragment	Turn off (default)/15S/30S/180S	<p>Clip: Captures a 15- or 30-second video clip that is ready to be shared on social media.</p> <p>Loop Video: Continuously captures video clips of 180 seconds.</p>
Audio	Stereo (default)/VE	<p>Stereo: Records stereo audio for better sound quality.</p> <p>VE (Vocal Enhancement): Records mono audio to reduce background noise for clear human voice.</p>
Dark Light Mode	Turn on /Turn off (default)	This mode uses a longer shutter speed to allow more light to enter the camera sensor. Not suitable for action-packed activities.
Distortion Correction	Turn on /Turn off (default)	With this feature enabled, the fisheye effect common in wide-angle captures will be corrected. But the view angle will be narrowed.
HindSight	Turn on/Turn off (default)	<p>HindSight can capture footage up to 15 seconds before you press the Shutter button, ensuring you never miss a moment.</p> <p>Note: To use this feature, please upgrade your camera to the latest version; this feature is only available in Video Mode.</p>

Photo Settings

Functions	Specifications	Note
Resolution	48MP (default)/12MP	General
	48MP (default)/12MP Interval: 0.5s/1s/2s/5s/10s/ 30s/1min/2min/5min/10min/ 30min/1h	Time Lapse Photo Mode

Metering	CAM (default) /AM/CM/SM/AFM	
EV	3.0/2.5/2.0/1.5/1.0/0.5/0 (default)/-0.5/-1.0/-1.5/-2.0/-2.5/-3.0	Sets the brightness of photos and videos. The higher the value, the brighter the video or photo.
ISO	Auto/100/200/400/800/1600	Sets the image sensor's sensitivity to light.
Shutter	Auto, 5S, 2S, 1/125S, 1/250S, 1/500S, 1/1000S, 1/2000S	Sets the length of time that a shutter remains open.
White Balance	Auto/2300K/2800K/3200K/4000K /4500K/5000K/5500K/6000k/6500K	Fine-tunes the color temperature of your videos and photos.
Sharpness	0/1/2/3 (default)/4/5/6	Sets the level of detail in your photos and videos.
Color	Normal (default)/Vivid	Choose the tonal quality.
Timer	Turn off (default)/3s/5s/10s/30s	Sets the countdown time to take a selfie.
Image Format	JPG (default)/JPG+RAW	Sets the output format for the image.
Burst	Turn off (default)/ 3 / 5 / 8	Sets the number of photos taken in Burst mode. Note: Ensure camera stability throughout the entire burst duration while using this mode.

Connecting to the AKASO GO App

You can connect your camera to the AKASO GO app via Wifi. To do this, download this app from the App Store or Google Play to your smartphone first. When your camera is connected to the AKASO GO app, you can control it to capture, or change its settings using your phone. You can also live preview, playback, download, edit, and share videos via this app. We recommend you connect Wifi before connecting to the AKASO GO app.

1. Turn on the camera's Wifi.

To turn on Wifi, tap the Wifi icon on the quick menu or enable "Wireless Connection" on the Preferences settings screen. The camera will enter Wifi mode and display the Wifi information in 3 seconds.

2. Connect Wifi.

Enter your phone's Wifi settings page, find the Wifi SSID in the list and tap on it, then enter the password 123456789 for connection.

Warm tip:

- ① Once the camera Wifi is connected, a "No Internet Connection" or "Weak Security" notification will appear since the phone's data is paused. You can ignore it and continue the app connection.

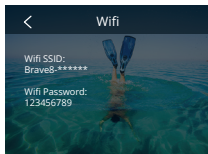
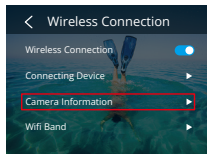
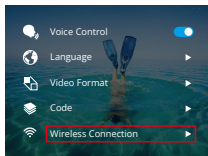
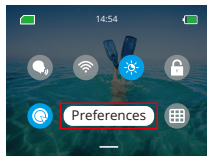

- ② When Wifi is successfully connected, the Wifi indicator will turn on, and the display screen will state "Connected to Brave_XXXX".
- ③ If Wifi isn't connected within 5 minutes, it will auto-disconnect. Enable Wifi again to reconnect.

3. Connect to the AKASO GO app.

Follow the steps below to connect your camera to the AKASO GO app.

- ① Open the AKASO GO app on your smartphone.
- ② Tap "Device" at the bottom, then tap "Add Device" in the upper left corner.
- ③ Select Brave 8 from the options.
- ④ Search for the camera's Wifi, then tap the "Connect" option in the bottom right corner.
- ⑤ Tap the "Join" option in the bottom right corner for connection.
- ⑥ Tap the "Connect" option at the bottom. Your camera is successfully connected to the AKASO GO app.

Tips:

- ① For a successful connection, first allow the app to access your Location and Local Network.
- ② If you failed to connect the camera's Wifi, please confirm if you successfully turned on the camera's Wifi. Please tap the "Research" option if you can't find the camera's Wifi.
- ③ The screenshots and steps below are for your reference only.

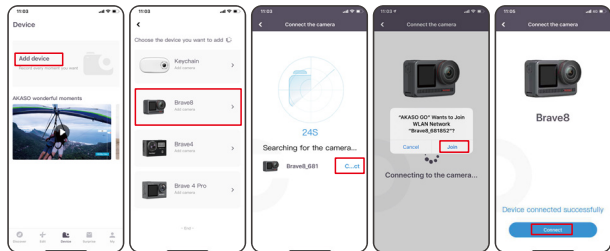

4. Control your camera with the AKASO GO app.

You can capture, playback, download, delete, and edit videos or photos using the phone app.

5. Disconnect from the app.

If you wish to disconnect your camera from the app, tap the "X" icon in upper left corner of the app, or press the Mode button to turn off Wifi.



6. Download SuperSmooth videos.

To get a SuperSmooth video, you need to record a video with SuperSmooth enabled, then download it from the app to your phone by following the steps below.

- 1 Enable SuperSmooth on the app. To do this, connect the AKASO GO app to the camera, tap the settings icon  in the upper right corner to access the app's settings screen, then tap "Image Stabilization" to select the "SuperSmooth" option.

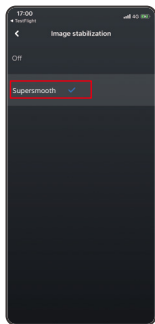
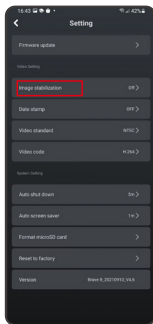
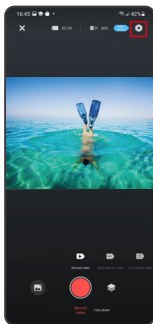
Tip: You can also enable SuperSmooth on the camera.



- ② Tap the Album icon  in the bottom left corner to enter the playback screen, select the video with the SuperSmooth icon  to view it in full screen, then tap the icon in the upper right corner and choose "Download".
- ③ Choose "SuperSmooth". After accessing the download screen, wait for the download progress to complete.
- ④ Once it is downloaded successfully, the video is processed by the SuperSmooth Stabilization algorithm. Please wait.
- ⑤ Once processed, the video is stored in your phone's album.

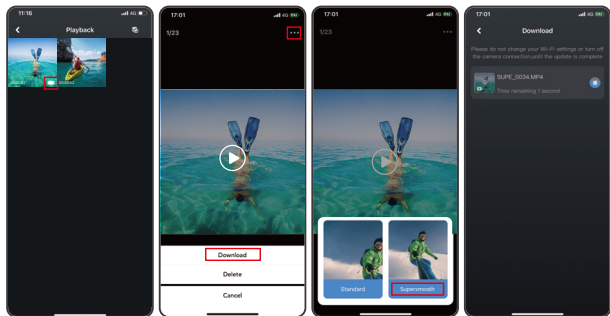

7. Firmware Upgrade Instructions.

- ① In the app's System Settings, tap "Firmware update". A pop-up window will show. Select "Upgrade firmware" and tap "Download".

Note: Before initiating the upgrade, make sure you've installed the latest AKASO GO app on your smartphone, and inserted the MicroSD card in the camera.

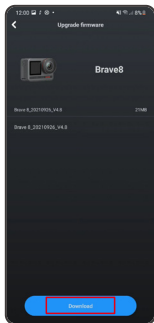

- ② Upon receiving a "Internet Connections" prompt, tap "Switch Networks" to access the network settings page. Then, switch to an available network and tap "done".

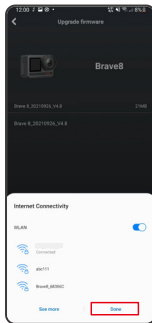
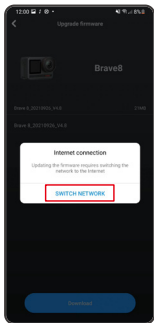

- ③ The app will automatically download the upgrade package. When the download progress is complete, tap "Connect camera". A "Connect to Device" prompt will appear. Please tap the "Connect" option on the prompt.

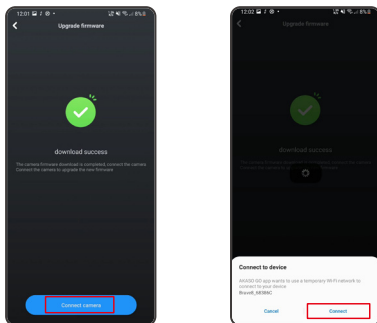

- ④ The system is now being upgraded.

Note: This usually takes about one minute. Please be patient. When the upgrade progress is complete, the app will show "Update Succeeded". Tap "Try it now" to use the camera of the up-to-date version.

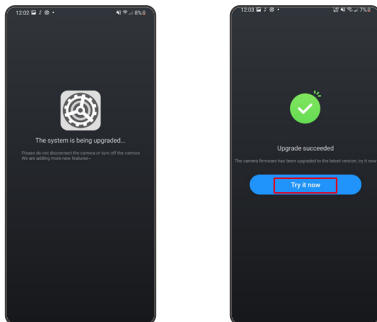

Playing Back Your Content

To playback your content on the Brave 8 camera, follow the steps below:

- ① Swipe right on the preview screen to bring up the most recently captured file, then tap the icon in the upper left corner to access all video and photo files.
- ② Tap "Video" or "Photo" to enter the video or photo set for file playback.

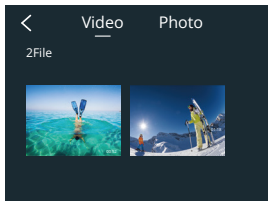
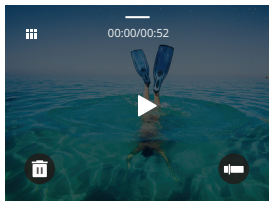

- ③ Tap the file you want you playback to see it in full-screen view, then tap the playback icon, and it will play.

Deleting Your Content

You can delete files from the album, video, and photo screens.

To delete files from the album screen, tap the Square icon in the upper right corner to select file (s) or deletion, then tap the Delete icon in the upper right corner followed by the "Confirm" option to complete the deletion of the selected files.

To delete files from the video screen, tap the Delete icon in the bottom left corner of the current video file, and select the "Confirm" option to complete the deletion of the selected file.

To delete files from the photo screen, tap the Delete icon at the bottom of the current photo file, and select the "Confirm" option to complete the deletion of the selected file.



Connecting to USB

You can connect your camera to a computer with the included USB cable. A message with 3 connection options will be displayed on the camera screen. Select **"USB Storage"** to establish a connection for file transfer between your camera and computer. Opt for **"PC Camera"** if you wish to utilize your camera as a Web camera. Alternatively, select **"Charging Mode"** to charge your camera.

Maintaining Your Camera

Please follow these guidelines to get the best performance from your camera:

1. For optimal audio performance, gently shake the camera or blow on the microphone to remove any debris from the microphone holes.
2. To clean the lens, use a soft, lint-free cloth to wipe it. Avoid inserting any foreign objects near the lens.
3. Do not touch the lens with your fingers.
4. Store the camera away from drops and bumps, as this may cause damage to the internal components.
5. Store the camera away from high temperatures and strong sunshine to protect it from damage.
6. Store the camera away from sharp objects and moisture-prone areas.



Maintaining Your Battery

If the battery reaches 0% while recording, the camera will save the file and the power goes off.

To maximize battery life, please follow these guidelines if possible:

- Turn off Wireless Connections when not using
- Capture videos at lower frame rates and resolutions
- Use the screen saver setting

Battery Storage and Operation

- If storing for extended periods, maintain a battery charge of 50-60%. Charge every 3 months and discharge the battery every 6 months.
- Do not store the battery with metal objects such as coins, keys, or necklaces. If the battery terminals come close to metal objects, a short circuit may cause fire.
- Store the battery in dry areas, safe from potential physical damage caused by squeezing or collision.
- Avoid using or storing the battery at high temperatures, such as in direct sunlight or a hot compartment. The battery will heat up, malfunction, or have its service life shortened in these conditions.
- Avoid using or storing the battery in low-temperature environments, as this will shorten the battery life or cause it to malfunction.
- Avoid environments with strong static or magnetic fields; these can compromise the battery's protective unit, posing safety risks.
- If the battery emits an odor, overheats, changes color, gets distorted, or exhibits any anomalies, discontinue use and remove it immediately from the camera or the battery charger whether it is being used, charged, or stored.
- Safely insulate used electrodes to prevent potential hazards.



Remote Control

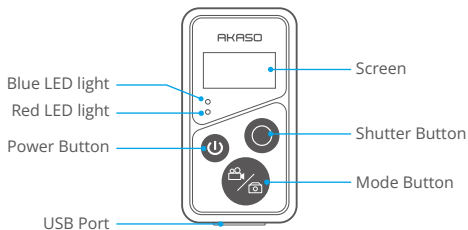

Note: The remote is not waterproof but splashproof only.

With the camera connected to the included remote, you can remotely control the camera to take photos or record videos. Below is a list of instructions for using the remote control.

Note: To ensure successful remote control, ensure the remote is sufficiently charged and operated with 10 meters of distance when using it to control your camera.

1. Power on or off / Pair

Function	Operation Status	Operation	Detail
Power on	Off	Press the Power button	Press the Power button to turn on the remote control. The red and blue indicators on the remote will be flashing quickly.
Pair	Pairing	Press the Mode and Shutter buttons.	1. Enable the Remote feature on the camera. To do this, swipe down to access the quick menu and locate "Remote", then turn on the remote feature by using the slide switch.



2. Press and hold the remote's Mode and Shutter buttons at the same time till its screen displays the date.

The two indicators will stop flashing. Now the remote is successfully connected to your camera.

Warm tip: The remote will be automatically connected to the camera in your second use.

Power off	On	Press the Power button	Press the Power button again to turn off the remote control.
-----------	----	------------------------	--

2. Use the shutter button

Function	Operation Status	Operation	Detail
Record videos	Video Mode On	Press the Shutter button	Press the Shutter button to start recording. Press again to stop recording.
Take photos	Photo Mode On	Press the Shutter button	Press the Shutter button to take a photo.

3. Switch modes

Function	Operation Status	Operation	Detail
Switch mode	Video or Photo Mode On	Press the Mode button	Press the Mode button to toggle between the video and photo modes.

4. Turn off the camera

Function	Operation Status	Operation	Detail
Control the camera to shut down	On	Press and hold the Power button for 5 seconds	Press and hold the Power button for 5 seconds to turn off the camera. The remote is also turned off.

5. Indicator status description

Blue Light	Red Light	Status Description
Off	Off	Power off
Flash quickly	Flash quickly	Not paired
Off	Off	Work mode (power on)
Flash slowly	/	Video Recording
/	Keep on (charging status)	The remote is charging
/	Off (charging status)	The remote is fully charged

6. Charge the remote

Connect the remote to a USB adapter using a USB cable. The red indicator will remain on while charging and black out when the remote is fully charged.

Tip: Once fully charged, disconnect the cable and ensure the charging cover is securely fastened.



Contact Us

For any inquiries about AKASO products, please feel free to contact us.
We will respond within 24 hours.

Tel: (888) 466-9222 (US)

Email: cs@akasotech.com

Web: www.akasotech.com

